

# Chroma-Q<sup>®</sup> Color Span 2<sup>™</sup>

User Manual



**Chroma-Q<sup>®</sup>**  
BRILLIANT SOLUTIONS

**Part Number:** CHSPPS02, CHSPPS06, CHSPPS18

**Software Version 1.6**  
Manual PN: 633-0500

# Warranty Statement



Chroma-Q warrants to the original purchaser, with proof of purchase, that its delivered products shall be free from defects in material and workmanship under normal use for a period of 24 months from date of shipment.

Chroma-Q will repair, or at its option, provide an equivalent item or replace, the defective product during the stated warranty period. This warranty applies only to the repair or replacement of the product and only when the product is properly handled, installed and maintained according to Chroma-Q instructions. This warranty excludes defects resulting from improper handling, storage, installation, acts of God, fire, vandalism or civil disturbances. Purchaser must notify Chroma-Q in writing within 14 days of noticing the defect. This warranty excludes field labour or service charges related to the repair or replacement of the product.

The warranty contained herein shall not extend to any finished goods or spare parts from which any serial number has been removed or which have been damaged or rendered defective (a) as a result of normal wear and tear, wilful or accidental damage, negligence, misuse or abuse; (b) due to water or moisture, lightning, windstorm, abnormal voltage, harmonic distortion, dust, dirt, corrosion or other external causes; (c) by operation outside the specifications contained in the user documentation; (d) by the use of spare parts not manufactured or sold by Chroma-Q or by the connection or integration of other equipment or software not approved by Chroma-Q unless the Customer provides acceptable proof to Chroma-Q that the defect or damage was not caused by the above; (e) by modification, repair or service by anyone other than Chroma-Q, who has not applied for and been approved by Chroma-Q to do such modification, repair or service unless the Customer provides acceptable proof to Chroma-Q that the defect or damage was not caused by the above; (f) due to procedures, deviating from procedures specified by Chroma-Q or (g) due to failure to store, install, test, commission, maintain, operate or use finished goods and spare parts in a safe and reasonable manner and in accordance with Chroma-Q's instructions (h) by repair or replacement of engines without factory training.

The warranty contained herein shall not apply to finished goods or spare parts which are sold "as is", as "second-hand", as used", as "demo" or under similar qualifications or to Consumables ("Consumables" is defined as any part(s) of goods or part(s) for use with goods, which part(s) of goods or part(s) for use with goods are consumed during the operation of the goods and which part(s) of goods or part(s) for use with goods require replacement from time to time by a user such as, but not limited to, light bulbs).

The warranty contained herein shall not apply, unless the total purchase price for the defective finished goods or spare parts has been paid by the due date for payment.

The warranty contained herein applies only to the original purchaser and are not assignable or transferable to any subsequent purchaser or end-user.

This warranty is subject to the shipment of the goods, within the warranty period, to the Chroma-Q warranty returns department, by the purchaser, at the purchasers expense. If no fault is found, Chroma-Q will charge the purchaser for the subsequent return of the goods.

Chroma-Q reserves the right to change the warranty period without prior notice and without incurring obligation and expressly disclaims all warranties not stated in this limited warranty.

## Disclaimer

The information contained herein is offered in good faith and is believed to be accurate. However, because conditions and methods of use of our products are beyond our control, this information should not be used in substitution for customer's tests to ensure that Chroma-Q products are safe, effective, and fully satisfactory for the intended end use. Suggestions of use shall not be taken as inducements to infringe any patent. Chroma-Q sole warranty is that the product will meet the sales specifications in effect at the time of shipment. Your exclusive remedy for breach of such warranty is limited to refund of purchase price or replacement of any product shown to be other than as warranted.

Chroma-Q reserves the right to change or make alteration to devices and their functionality without notice due to our ongoing research and development.

The Chroma-Q Color Span 2 range has been designed specifically for the lighting industry. Regular maintenance should be performed to ensure that the products perform well in the entertainment environment.

If you experience any difficulties with any Chroma-Q products please contact your selling dealer. If your selling dealer is unable to help please contact [support@chroma-q.com](mailto:support@chroma-q.com). If the selling dealer is unable to satisfy your servicing needs, please contact the following, for full factory service:

Outside North America:  
Tel: +44 (0)1494 446000  
Fax: +44 (0)1494 461024  
[support@chroma-q.com](mailto:support@chroma-q.com)

North America:  
Tel: 416-255-9494  
Fax: 416-255-3514  
[support@chroma-q.com](mailto:support@chroma-q.com)

For further information please visit the Chroma-Q website at [www.chroma-q.com](http://www.chroma-q.com).

Chroma-Q and Color Span 2 are trademarks, for more information on this visit [www.chroma-q.com/trademarks](http://www.chroma-q.com/trademarks).

The rights and ownership of all trademarks are recognised.

### Important Notice:

As per the requirements in the Occupational Safety and Health Administration standards for product approval, please refer to the OSHA web pages <http://www.osha.gov/dts/otpc/nrtl/> for information on the list of Nationally Recognized Testing Laboratories (NRTLs) and the scope of recognition.

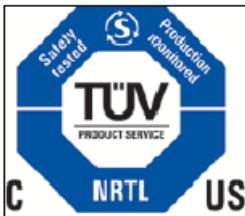

# Table of Contents

<b>1.</b>	<b>Product overview</b> .....	<b>4</b>
<b>2.</b>	<b>Operation</b> .....	<b>8</b>
2.1	Unpacking the Units .....	8
2.2	Cabling .....	8
2.3	Mounting .....	10
2.4	Control.....	10
2.5	DMX Protocol .....	16
<b>3.</b>	<b>Troubleshooting</b> .....	<b>24</b>
<b>4.</b>	<b>Specification</b> .....	<b>25</b>
4.1	Technical Specifications .....	25
4.2	Drawings – Dimensions .....	27
<b>5.</b>	<b>Maintenance</b> .....	<b>33</b>

# 1. Product overview

The Chroma-Q Color Span 2 is a configurable low profile, ultra bright LED cove lighting and wall wash system for wide ranging applications. The fixture gives lighting designers, specifiers and end users the flexibility to specify many aspects of its design to meet their particular application needs, including:

- IP rating: Indoor (IP20) or outdoor (IP67) rated use
- Body length: 400mm / 16", 800mm / 32" or 1200mm / 48"
- Body color: 10 colors, including stock Black, White or Silver
- LED colors: RGBA, single color Red, Green, Blue, Amber, Cool White, Warm White, or any color combination
- Optics: Narrow, medium or wide beam angles

This vast range of configurations, combined with a very powerful 2000 lumens output per 1.2m / 4 foot and ultra slim design, makes the Color Span 2 suitable for a wide range of wall wash, cove, effects and feature lighting applications in the architectural and entertainment sectors.

As well as benefiting from the same high quality components and innovative LED technologies found in other leading Chroma-Q LED products, the fixture's highly efficient solid-state technology requires less power and maintenance compared to conventional luminaires, enabling it to wash a 21.6m / 72 foot long wall from just a single wall outlet.

- Configure the IP rating, body length, body color, LED colors (4 circuits) and optics
  - Low profile LED cove lighting and wall wash system
  - Ultra bright - 2000 lumens per 1.2m / 4ft
  - Choice of 2, 6 & 18 way power supplies
  - Smooth, linear dimming curve
  - Optional RGBA \*Magic Amber™ configuration
- \*Magic Amber is the term used for the unit's ability to bring in Amber when mixing colors that require it

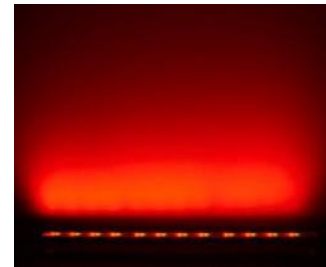

## Note: HANDHELD COLOR METERS

Handheld Color Meters provide a limited measuring range for LED fixtures, which results in inconsistent and unreliable data.

All photometric values listed in this document are based on testing and measurements conducted by certified independent laboratories with reference to the IES standards.

## 1.1 Chroma-Q Color Span 2 IP20 fixture unit

The Color Span 2 IP20 fixtures come in lengths of 400mm / 16" with 16 high power LEDs, 800mm / 32" with 32 high power LEDs and 1200mm / 48" with 48 high power LEDs. Each fixture regardless of length and number of LEDs shall have a total of 4 channels all the time. (See illustration below) A fixture unit can be built to have a variety of LED colors for each of the 4 channels. The fixture enclosure units come in custom colors and are suitable for interior applications. The high-strength extruded and anodised aluminium construction offers complete protection and houses a discreet cable management.



400 mm (16") Color Span Fixture

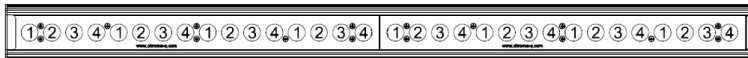

800 mm (32") Color Span Fixture



1200 mm (48") Color Span Fixture

## 1.2 Chroma-Q Color Span 2 IP67 fixture unit

The Color Span IP67 fixture is a sealed enclosure made of a heavier gauge anodised aluminium extrusion that is suitable for external applications. The units are available in custom colors, and come in lengths of 400mm / 16" with 16 high power LEDs, 800mm / 32" with 32 high power LEDs and 1200mm / 48" with 48 high power LEDs. Each fixture regardless of length and number of LEDs shall have a total of 4 channels all the time. (See illustration below). A fixture unit can be built to have a variety of LED colors for each of the 4 channels. (See illustration below) The cable system for a Color Span IP67 fixture shall be customised to suit the application requirements.



400mm (16") Color Span IP67 Fixture



800mm (32") Color Span IP67 Fixture



1200mm (48") Color Span IP67 Fixture

### 1.3 Chroma-Q Color Span power supply units

A range of DMX controlled power supplies are available to accommodate most applications. Each Color Span Power Supply features outputs via RJ45. The unit can be controlled remotely via ANSI E1.11 USITT DMX 512-A (XLR-5 pin).

The control options incorporate the HSI (Hue, Saturation and Intensity), RGB (Red, Green, Blue with Magic Amber\*), RGBA (Red, Green, Blue and Amber) control modes and a dynamic variable effects engine integrated in the software which gives the lighting designer full control over color and effects combinations.

\* Magic Amber is the term used for the unit's ability to bring in Amber when mixing colors that require it.

The RJ45 output connectors of the Color Span PSU units are color coded to indicate the appropriate Color Span 2 fixture units.

Output Color Coding:

Output Color Code	Number of LED	Fixture Length	Fixture Length (mm)
Brown	16	16	400
Orange	32	32	800
Yellow	48	48	1200

The Color Span PS02 is a power supply with 2 outputs suitable for 2 full size (1200mm) 48 LED Color Span 2 fixture units, or 2 (800mm) 32 LED Color Span 2 fixture units, or 2 (400mm) 16 LED Color Span 2 fixture units. Color Span 2 fixtures can be combined (daisy-chained) to match each of the outputs of the Color Span PS02 power supply unit. (See chart and diagram in “Cabling” below.)

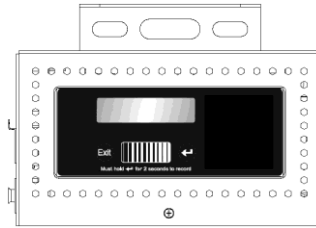

The Color Span PS06 is a power supply with 6 outputs suitable for a maximum of 6 full size (1200mm) 48 LED Color Span 2 fixture units, or 6 (800mm) 32 LED Color Span 2 fixture units, or 6 (400mm) 16 LED Color Span 2 fixture units. Color Span 2 fixtures can be combined (daisy-chained) to match each of the outputs of the Color Span PS06 power supply unit. (See chart and diagram in “Cabling” below.)

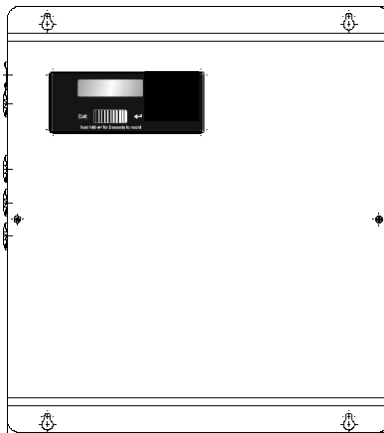

The Color Span PS18 is a power supply with 18 outputs suitable for a maximum of 18 full size (1200mm) 48 LED Color Span fixture units, or 18 (800mm) 32 LED Color Span 2 fixture units, or 18 (400mm) 16 LED Color Span 2 fixture units. Color Span 2 fixtures can be combined (daisy-chained) to match each of the outputs of the Color Span PS18 power supply unit. (See chart and diagram in “Cabling” below.) The Color Span PS18 fits a 2U 19” rack.

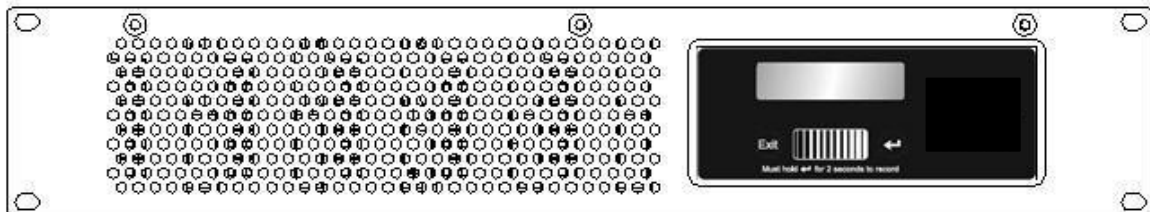



## 2. Operation

### 2.1 Unpacking the Units

The Color Span fixture package includes 1 unit Color Span 2 fixture with feet support.

The Color Span PS02 package includes 1 unit Color Span PS02 power supply unit and an IEC power cord.

The Color Span PS06 package includes 1 unit Color Span PS06 power supply unit and an IEC power cord.

The Color Span PS18 package includes 1 unit Color Span PS18 power supply unit with a 1 metre trailing lead.

### 2.2 Cabling

The Color Span 2 system utilises a CAT5 cable system with RJ45 chassis in/out to supply power and data from the power supply unit to the fixtures. Each output supports a maximum distance of 5m / 16'.

RJ45 (Pin to Pin) Wiring Diagram:

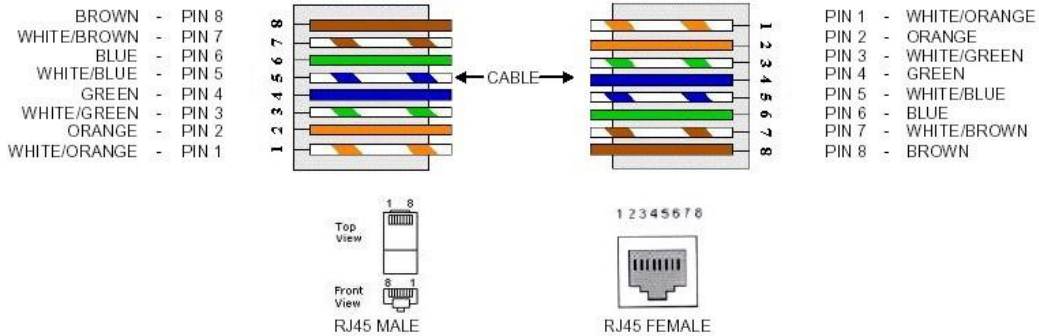

**Output and Cabling Configurations:**

The RJ45 output connectors of the Color Span PSU units are color coded to indicate the matching Color Span 2 fixture units.

**Output Color Coding:**

Output Color	Number of LEDs	Fixture Length	Fixture Length (mm)
Brown	16	16	400
Orange	32	32	800
Yellow	48	48	1200

**Output Configurations:**

PSU	Output	Configuration
PS02	Yellow	2 outputs x (48 LEDs fixture)
		2 outputs x (32 LEDs + 16 LEDs fixtures)
		2 outputs x (16 LEDs + 16 LEDs + 16 LEDs fixtures)
PS06	Yellow	6 outputs x (48 LEDs fixture)
		6 outputs x (32 LEDs + 16 LEDs fixtures)
		6 outputs x (16 LEDs + 16 LEDs + 16 LEDs fixtures)
PS06	Orange	6 outputs x (32 LEDs fixture)
		6 outputs x (16 LEDs + 16 LEDs fixtures)
		6 outputs x (16 LEDs fixture)
PS18	Yellow	18 outputs x (48 LEDs fixture)
		18 outputs x (32 LEDs + 16 LEDs fixtures)
		18 outputs x (16 LEDs + 16 LEDs + 16 LEDs fixtures)
PS18	Orange	18 outputs x (32 LEDs fixture)
		18 outputs x (16 LEDs + 16 LEDs fixtures)
		18 outputs x (16 LEDs fixtures)

**Output Color – Yellow:**

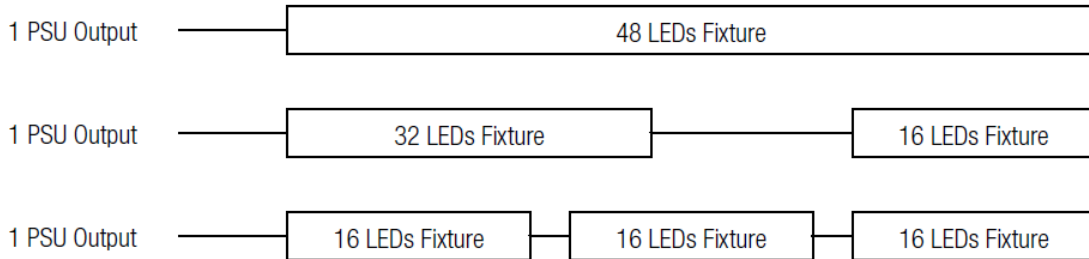

**Output Color – Orange:**

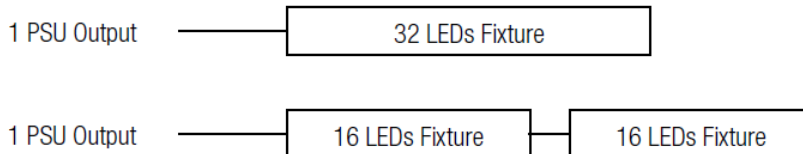

**Output Color – Brown:**

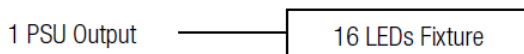

**Note:** Damage may occur to the fixture unit if it is not the appropriate size as indicated on each output connector of the PSU.

## 2.3 Mounting

The Color Span 2 fixtures are built with angle brackets for wall, ceiling & floor mounting.

The Color Span PS02 is designed for truss mounting.

The Color Span PS06 is designed for wall mounting.

The Color Span PS18 is designed for mounting in a 19" rack.

## 2.4 Control

The Color Span 2 system can operate as a stand-alone unit or controlled remotely via ANSI E1.11 USITT DMX 512-A signal protocol.

The Color Span power supply units can be set to operate in various modes. Single output, and all-grouped outputs are available with 5 control options: fxHSI, HSI, RGB(\*w/ Magic Amber), RGBA, RGBI, and pre-programmed looks and stand-alone effects.

The Color Span PS02/PS06/PS18 control menu items are accessed via the LCD display and the following controls:

- Right hand button (Arrow) = Enter (hold for 2 seconds to save). The display flashes before saving/recording.
- Left hand button (Exit) = Exit without saving
- Centre pressure slide pad = adjusts or scrolls through menu items

The LCD Screen shown below is currently at the Home position displays: Product Name, Software Version, current DMX Address, current Control Mode and Time



### Control Menu

Use the pressure slide pad to scroll through the control menu positions:

Home / DMX Address

To set the DMX start address of the PS02/PS06/PS18,

- 1 Press Enter, then use the slide pad to adjust the DMX start address.
- 2 Press Enter and hold for 2 seconds to save.



## Control Mode

The PS02/PS06/PS18 can be set to operate in various DMX controlled modes. The control options are:

- fxHSI (Hue, Saturation, Intensity and Effects)
- HSI (Hue, Saturation and Intensity),
- RGB (Red, Green, Blue with \*Magic Amber<sup>1</sup>)
- RGBA (Red, Green, Blue and Amber)
- RGBI (Red, Green, Blue with \*Magic Amber and Intensity)
- Pre-programmed looks and standalone effects.

- 1 From Home, use the slide pad to access Control Mode.
- 2 Press Enter, then use the slide pad to scroll and select the control mode.
- 3 Press Enter and hold for 2 seconds to save.

Color Span™ PS18 Power Supply Unit – Software Version 1.6				
Mode	Name	Ch	Grouping	Description
1	fxHSI	61	Variable	7 x effects + 18 x Hue, Saturation, Intensity
2	HSI	54	Single	18 x Hue, Saturation, Intensity
3	RGB	54	Single	18 x Red, Green, Blue (with *Magic Amber)
4	fxHSI	9	All grouped	6 x effects + Hue, Saturation, Intensity
5	HSI	3	All grouped	1 x Hue, Saturation, Intensity
6	RGB	3	All grouped	1 x Red, Green, Blue (with *Magic Amber)
7	RGBA	72	Single	18 x Red, Green, Blue, Amber
8	RGBI	72	Single	18 x Red, Green, Blue, Intensity (with *Magic Amber)
9	RGBA	4	All grouped	1 x Red, Green, Blue, Amber
10	RGBI	4	All grouped	1 x Red, Green, Blue, Intensity (with *Magic Amber)
11	LkSel	1	Variable	Selection of pre-programmed looks
12	DEMO			Stand-alone effects sequence

\* Magic Amber is the term used for the unit's ability to bring in Amber when mixing colors that require it

Color Span™ PS06 Power Supply Unit – Software Version 1.6				
Mode	Name	Ch	Grouping	Description
1	fxHSI	25	Variable	7 x Effects + 6 x Hue, Saturation, Intensity
2	HSI	18	Single	6 x Hue, Saturation, Intensity
3	RGB	18	Single	6 x Red, Green, Blue (with *Magic Amber)
4	fxHSI	9	All grouped	6 x effects + Hue, Saturation, Intensity
5	HSI	3	All grouped	1 x Hue, Saturation, Intensity
6	RGB	3	All grouped	1 x Red, Green, Blue (with *Magic Amber)
7	RGBA	24	Single	6 x Red, Green, Blue, Amber
8	RGBI	24	Single	6 x Red, Green, Blue, Intensity (with *Magic Amber)
9	RGBA	4	All grouped	1 x Red, Green, Blue, Amber
10	RGBI	4	All grouped	1 x Red, Green, Blue, Intensity (with *Magic Amber)
11	LkSel	1	Variable	Selection of pre-programmed looks
12	DEMO			Stand-alone effects sequence

\* Magic Amber is the term used for the unit's ability to bring in Amber when mixing colors that require it

Color Span™ PS02 Power Supply Unit – Software Version 1.6				
Mode	Name	Ch	Grouping	Description
1	fxHSI	13	Variable	7 x effects + 2 x Hue, Saturation, Intensity
2	HSI	6	Single	2 x Hue, Saturation, Intensity
3	RGB	6	Single	2 x Red, Green, Blue (with *Magic Amber)
4	fxHSI	9	All grouped	6 x effects + Hue, Saturation, Intensity
5	HSI	3	All grouped	1 x Hue, Saturation, Intensity
6	RGB	3	All grouped	1 x Red, Green, Blue (with *Magic Amber)
7	RGBA	8	Single	2 x Red, Green, Blue, Amber
8	RGBI	8	Single	2 x Red, Green, Blue, Intensity (with *Magic Amber)
9	RGBA	4	All grouped	1 x Red, Green, Blue, Amber
10	RGBI	4	All grouped	1 x Red, Green, Blue, Intensity (with *Magic Amber)
11	LkSel	1	Variable	Selection of pre-programmed looks
12	DEMO			Stand-alone effects sequence

\* Magic Amber is the term used for the unit's ability to bring in Amber when mixing colors that require it



#### When DMX is Lost

If DMX is not detected various output options can be selected:

- 4 From Home, use the slide pad to access When DMX is Lost.
- 5 Press Enter, then scroll to select from the options.
- 6 Press Enter and hold for 2 seconds to save.

The options are:

- Off - will snap to off
- Hold - will hold last valid DMX state
- Trig - will default to Time Triggers mode
- Look 1-42 - will snap to the Look of your choice



## Look Store

The PS02/PS06/PS18 has 42 internal FX Looks for standalone operation, 1-9 are preset.

To replay a Look,

- 1 From Home, use the slide pad to access Look Store.
- 2 Press Enter then scroll through the Looks.

Note: DMX has priority over internal Looks.

Looks can be recorded to the internal flash memory by users and will be preserved on power down. However, looks will be returned to default setting if menu Reset to Default is performed.

There are two ways to record a look:

Simple, with DMX console.

- 1 Set the Control Mode of the PS02/PS06/PS18 to Lk Sel.
- 2 Use a DMX console to adjust channel levels and create the desired look or effect.
- 3 From Home, use the slide pad to access Look Store.
- 4 Press Enter, and then scroll to the desired Look number.
- 5 Press Enter, and then press Enter again and hold for 2 seconds to save the Look.

Advanced, standalone. (DMX is unplugged)

- 1 Use the slide pad to access Look Store.
- 2 Press Enter then scroll to the desired Look.
- 3 Press Enter to access the memory data. The memory data is presented as two numbers separated by a letter "c". The number to the left of the "c" is the channel number and to the right is the channel level. Pressing Up/Down up to the far end will show the Mode at which the selected Look was programmed.

To edit the Mode of a selected Look:

- 1 Use the slide pad to access Look Store.
- 2 Press Enter then scroll to the desired Look.
- 3 Press Enter to access the memory data.
- 4 Scroll to the far end until the Mode number is shown.
- 5 Press Enter then scroll to adjust the Mode number.
- 6 Press Enter to go back to the channel numbers.

To edit the channel numbers and levels of a selected Look:

- 1 Use the slide pad to access Look Store.
- 2 Press Enter then scroll to the desired Look.
- 3 Press Enter to access the memory data.
- 4 Scroll and select the channel number.

To edit the channel level:

- 1 Press Enter then use the slide pad to adjust the level (shown as 0-255).
- 2 Press Enter to toggle back to the channel numbers.
- 3 Press Enter and hold for 2 seconds to save the edited Look.



#### Time Triggers

The PS02/PS06/PS18 has real time triggering of the internal Looks.

- 1 From Home, use the slide pad to access Time Triggers.
- 2 Press Enter and display shows the Day, Hour and Minutes and Look.
- 3 Press Enter then use the slide pad to toggle between Day, Hour (24), Minutes and Look to be triggered.
- 4 Press Enter and hold for 2 seconds to save.

By default Time Triggers will occur on all 7 days unless specified. The triggers will only be activated when the feature "When DMX is Lost" is set to Trig.



#### Set Day and Time

- 1 From Home, use the slide pad to access Set Day and Time.
- 2 Press Enter and use the slide pad to toggle between Day, Hour (24) and Minutes.
- 3 Press Enter and hold for 2 seconds to save.



#### Displ. Backlight

The LCD backlight can be set to go off after 5 seconds of no activity.

- 1 From Home, use the slide pad to access Displ.Backlight.
- 2 Press Enter, then use the slide pad to select On (permanently) or Off (after 5 seconds).
- 3 Press Enter and hold for 2 seconds to save.



#### Reset to Default

- 1 From Home, use the slide pad to access Reset to Default.
- 2 Press Enter and hold for 2 seconds to reset all menu items to factory defaults.

Factory defaults are:

DMX address = 001

Control Mode = 1

DMX Lost = Hold

Looks = 1

Time Triggers = deleted

Display = On.



#### Frequency

The PS02/PS06/PS18 has four frequency settings available – 360, 600, 1200, 2400.

This allows for the LED scan rate to be synchronised with the video camera and avoid a flickering effect.

- 1 From Home, use the slide pad to access Frequency.
- 2 Press Enter, and then scroll to select the frequency.
- 3 Press Enter and hold for 2 seconds to save.

## Control options

### 3 channel HSI (Hue, Saturation and Intensity):

gives 2 color channels for hue and saturation and a separate intensity channel. A separate definable intensity channel is particularly useful when creating intensity chases or when the grand master is used. The hue channel has 255 different colors available and the saturation channel specifies the saturation level of that color. The saturation channel is fully saturated at full. White is achieved with the intensity channel to full and the saturation channel at zero.

### 3 channel RGB (Red, Green, Blue with \*Magic Amber):

is the more traditional way of controlling color changing LED fixtures. Each of the three control channels directly affects the intensity of the corresponding LED. Color is mixed by adjusting the levels of the three primary colors. White is achieved with all channels at full.

### 3 channel RGB + 1 intensity channel (Red, Green, Blue with \*Magic Amber and Intensity):

gives 3 control channels directly affecting the intensity of the corresponding LED – Red, Green, Blue with \*Magic Amber, and 1 channel affecting the intensity of all RGB channels.

### 4 channel RGBA (Red, Green, Blue and Amber):

gives 4 control channels directly affecting the intensity of the corresponding LED – Red, Green, Blue and Amber. Color is mixed by adjusting the levels of each of the four colors. White is achieved with all channels at full.

### Internal FX engine:

Modes 1 and 4 incorporate a comprehensive internal FX engine with seven variable parameters to create an unlimited amount of unique lighting effects.

### Descriptions for the effects channels included in the following modes: Mode 1:

Ch1 – Grouping, variable grouping facility to run FX / within groups

Ch2 – Color Speed, variable speed of color scrolling

Ch3 – Color Fan, variable fan of color between / within groups

Ch4 – Color Range, variable limit of spectrum range for color scrolling

Ch5 – Color Step, variable control of smoothness of color scrolling

Ch6 – Intensity Effects, wide selection of intensity fading and snapping effects

Ch7 – Intensity Fan, variable fan of intensity effects

### Mode 4:

Ch1 – Color Speed, variable speed of color scrolling

Ch2 – Color Fan, variable fan of color between / within groups

Ch3 – Color Range, variable limit of spectrum range for color scrolling

Ch4 – Color Step, variable control of smoothness of color scrolling

Ch5 – Intensity Effects, wide selection of intensity fading and snapping effects

Ch6 – Intensity Fan, variable fan of intensity effects

\* Magic Amber is the term used for the unit's ability to bring in Amber when mixing colors that require it



## 2.5 DMX Protocol

### Color Span PS18 DMX Personality Mode 1-3:

(Mode 1 – grouping is Variable, Mode 2 & 3 – each single output is 1 group)

Color Span 2 v1.6	Control Mode 1 [61ch] 7fx + 18 x HSI	Control Mode 2 [54ch] 18 x HSI	Control Mode 3 [54ch] 18 x RGB (with *Magic Amber)
Channel 1	Grouping 0-100 Variable grouping range between 1-18 cells with FX running within the group. 102-206 variable grouping range between 1-18 cells with FX running between the groups. 209-255 Variable grouping range for every 2nd to every 18th cell in a group.	Hue for output 1	Red for output 1
Channel 2	Color Speed 0-255 Variable speed of color scrolling. From static at 0 to maximum at 255.	Saturation for output 1	Green for output 1
Channel 3	Color Fan 0-255 Variable fan of color between / within groups. All units are the same color at 0.	Intensity for output 1	Blue for output 1
Channel 4	Color Range 0 Full spectrum 1-255 Variable limit of spectrum for color scrolling. Single color at 1, full spectrum at 255.	Hue for output 2	Red for output 2
Channel 5	Color Step 0-255 Variable control of smoothness of color scrolling. Smoothest is at 0. Most coarse is at 250. Rate will vary with scrolling speed. 255 will override effects and switch to RGB.	Saturation for output 2	Green for output 2
Channel 6	Intensity Effects 0 Static 1-63 Fade on, fade off. Variable range, 63 the fastest 64-127 Fade on, snap off. Variable range, 127 the fastest 128-191 Snap on, fade off. Variable range, 191 the fastest. 192-255 Snap on, snap off (strobe). Variable range, 255 the fastest.	Intensity for output 2	Blue for output 2
Channel 7	Intensity Fan 0-255 Variable fan of intensity effect between / within groups. All units at the same intensity at 0. Alternating units on and off at 255.	Hue for output 3	Red for output 3
Channel 8	Hue for output 1	Saturation for output 3	Green for output 3
Channel 9	Saturation for output 1	Intensity for output 3	Blue for output 3
Channel 10	Intensity for output 1	Hue for output 4	Red for output 4
Channel 11	Hue for output 2	Saturation for output 4	Green for output 4
Channel 12	Saturation for output 2	Intensity for output 4	Blue for output 4
Channel 13	Intensity for output 2	Hue for group output 5	Red for output 5
	...and so on up to output 18	...and so on up to output 18	...and so on up to output 18
Total DMX Channels	61 DMX channels	54 DMX channels	54 DMX channels

Color Span PS18 DMX Personality Mode 4-6: (All 18 outputs is 1 group)

Color Span 2 v1.6	Control Mode 4 [9ch] 6fx + HSI	Control Mode 5 [3ch] 1 x HSI	Control Mode 6 [3ch] 1 x RGB (with *Magic Amber)
Channel 1	Color Speed 0-255 Variable speed of color scrolling. From static at 0 to maximum at 255.	Hue for all 18 outputs	Red for all 18 outputs
Channel 2	Color Fan 0-255 Variable fan of color between / within groups. All units are the same color at 0.	Saturation for all 18 outputs	Green for all 18 outputs
Channel 3	Color Range 0 Full spectrum 1-255 Variable limit of spectrum for color scrolling. Single color at 1, full spectrum at 255.	Intensity for all 18 outputs	Blue for all 18 outputs
Channel 4	Color Step 0-255 Variable control of smoothness of color scrolling. Smoothest is at 0. Most coarse is at 250. Rate will vary with scrolling speed. 255 will override effects and switch to RGB.		
Channel 5	Intensity Effects 0 Static 1-63 Fade on, fade off. Variable range, 63 the fastest 64-127 Fade on, snap off. Variable range, 127 the fastest 128-191 Snap on, fade off. Variable range, 191 the fastest. 192-255 Snap on, snap off (strobe). Variable range, 255 the fastest.		
Channel 6	Intensity Fan 0-255 Variable fan of intensity effect between / within groups. All units at the same intensity at 0. Alternating units on and off at 255.		
Channel 7	Hue for all 18 outputs		
Channel 8	Saturation for all 18 outputs		
Channel 9	Intensity for all 18 outputs		
Channel 10			
Channel 11			
Channel 12			
Channel 13			
Total DMX Channels	9 DMX channels	3 DMX channels	3 DMX channels

Color Span PS18 DMX Personality Mode 7-10:

(Mode 7 & 8 – each output is 1 group/cell; Mode 9 & 10 – all 18 outputs is 1 group)

ColorSpan2 v1.6	Control Mode 7 [72ch] 18 x RGBA	Control Mode 8 [72ch] 18 x RGBI (with *Magic Amber)	Control Mode 9 [4ch] 1 x RGBA	Control Mode 10 [4ch] 1 x RGBI (with *Magic Amber)
Channel 1	Red for output 1	Red for output 1	Red for all 18 outputs	Red for all 18 outputs
Channel 2	Green for output 1	Green for output 1	Green for all 18 outputs	Green for all 18 outputs
Channel 3	Blue for output 1	Blue for output 1	Blue for all 18 outputs	Blue for all 18 outputs
Channel 4	Amber for output 1	Intensity for output 1	Amber for all 18 outputs	Intensity for all 18 outputs
Channel 5	Red for output 2	Red for output 2		
Channel 6	Green for output 2	Green for output 2		
Channel 7	Blue for output 2	Blue for output 2		
Channel 8	Amber for output 2	Intensity for output 2		
Channel 9	Red for output 3	Red for output 3		
Channel 10	Green for output 3	Green for output 3		
Channel 11	Blue for output 3	Blue for output 3		
Channel 12	Amber for output 3	Intensity for output 3		
Channel 13	Red for output 4	Red for output 4		
	...and so on up to output 18	...and so on up to output 18		
Total DMX Channels	72 DMX channels	72 DMX channels	4 DMX channels	4 DMX channels

Color Span PS06 DMX Personality Mode 1-3:

(Mode 1 – grouping is Variable, Mode 2 & 3 – each single output is 1 group)

ColorSpan2 v1.6	Control Mode 1 [25ch] 7fx + 6 x HSI	Control Mode 2 [18ch]6xHSI	Control Mode 3 [18ch]6 x RGB (with *Magic Amber)
Channel 1	Grouping 0-100 Variable grouping range between 1-6 cells with FX running within the group. 102-206 variable grouping range between 1-6 cells with FX running between the groups. 209-255 Variable grouping range for every 2nd to every 18th cell in a group.	Hue for output 1	Red for output 1
Channel 2	Color Speed 0-255 Variable speed of color scrolling. From static at 0 to maximum at 255.	Saturation for output 1	Green for output 1
Channel 3	Color Fan 0-255 Variable fan of color between / within groups. All units are the same color at 0.	Intensity for output 1	Blue for output 1
Channel 4	Color Range 0 Full spectrum 1-255 Variable limit of spectrum for color scrolling. Single color at 1, full spectrum at 255.	Hue for output 2	Red for output 2
Channel 5	Color Step 0-255 Variable control of smoothness of color scrolling. Smoothest is at 0. Most coarse is at 250. Rate will vary with scrolling speed. 255 will override effects and switch to RGB.	Saturation for output 2	Green for output 2
Channel 6	Intensity Effects 0 Static 1-63 Fade on, fade off. Variable range, 63 the fastest 64-127 Fade on, snap off. Variable range, 127 the fastest 128-191 Snap on, fade off. Variable range, 191 the fastest. 192-255 Snap on, snap off (strobe). Variable range, 255 the fastest.	Intensity for output 2	Blue for output 2
Channel 7	Intensity Fan 0-255 Variable fan of intensity effect between / within groups. All units at the same intensity at 0. Alternating units on and off at 255.	Hue for output 3	Red for output 3
Channel 8	Hue for output 1	Saturation for output 3	Green for output 3
Channel 9	Saturation for output 1	Intensity for output 3	Blue for output 3
Channel 10	Intensity for output 1	Hue for output 4	Red for output 4
Channel 11	Hue for output 2	Saturation for output 4	Green for output 4
Channel 12	Saturation for output 2	Intensity for output 4	Blue for output 4
Channel 13	Intensity for output 2	Hue for group output 5	Red for output 5
	...and so on up to output 6	...and so on up to output 6	...and so on up to output 6
Total DMX Channels	25 DMX channels	18 DMX channels	18 DMX channels

Color Span PS06 DMX Personality Mode 4-6: (All 6 outputs as 1 group)

ColorSpan2 v1.6	Control Mode 4 [9ch] 6fx + HSI	Control Mode 5 [3ch] 1 x HSI	Control Mode 6 [3ch] 1 x RGB (with *Magic Amber)
Channel 1	Color Speed 0-255 Variable speed of color scrolling. From static at 0 to maximum at 255.	Hue for all 6 outputs	Red for all 6 outputs
Channel 2	Color Fan 0-255 Variable fan of color between / within groups. All units are the same color at 0.	Saturation for all 6 outputs	Green for all 6 outputs
Channel 3	Color Range 0 Full spectrum 1-255 Variable limit of spectrum for color scrolling. Single color at 1, full spectrum at 255.	Intensity for all 6 outputs	Blue for all 6 outputs
Channel 4	Color Step 0-255 Variable control of smoothness of color scrolling. Smoothest is at 0. Most coarse is at 250. Rate will vary with scrolling speed. 255 will override effects and switch to RGB.		
Channel 5	Intensity Effects 0 Static 1-63 Fade on, fade off. Variable range, 63 the fastest 64-127 Fade on, snap off. Variable range, 127 the fastest 128-191 Snap on, fade off. Variable range, 191 the fastest. 192-255 Snap on, snap off (strobe). Variable range, 255 the fastest.		
Channel 6	Intensity Fan 0-255 Variable fan of intensity effect between / within groups. All units at the same intensity at 0. Alternating units on and off at 255.		
Channel 7	Hue for all 6 outputs		
Channel 8	Saturation for all 6 outputs		
Channel 9	Intensity for all 6 outputs		
Total DMX Channels	9 DMX channels	3 DMX channels	3 DMX channels

Color Span PS06 DMX Personality Mode 7-10:

(Mode 7 & 8 – each output is 1 group/cell; Mode 9 & 10 – all 6 outputs is 1 group)

ColorSpan2 v1.6	Control Mode 7 [24ch] 6 x RGBA	Control Mode 8 [24ch] 6 x RGBI (with *Magic Amber)	Control Mode 9 [4ch] 1 x RGBA	Control Mode 10 [4ch] 1 x RGBI (with *Magic Amber)
Channel 1	Red for output 1	Red for output 1	Red for all 6 outputs	Red for all 6 outputs
Channel 2	Green for output 1	Green for output 1	Green for all 6 outputs	Green for all 6 outputs
Channel 3	Blue for output 1	Blue for output 1	Blue for all 6 outputs	Blue for all 6 outputs
Channel 4	Amber for output 1	Intensity for output 1	Amber for all 6 outputs	Intensity for all 6 outputs
Channel 5	Red for output 2	Red for output 2		
Channel 6	Green for output 2	Green for output 2		
Channel 7	Blue for output 2	Blue for output 2		
Channel 8	Amber for output 2	Intensity for output 2		
Channel 9	Red for output 3	Red for output 3		
Channel 10	Green for output 3	Green for output 3		
Channel 11	Blue for output 3	Blue for output 3		
Channel 12	Amber for output 3	Intensity for output 3		
Channel 13	Red for output 4	Red for output 4		
	...and so on up to output 6	...and so on up to output 6		
Total DMX Channels	24 DMX channels	24 DMX channels	4 DMX channels	4 DMX channels

Color Span PS02 DMX Personality Mode 1-3:

(Mode 1 – grouping is Variable, Mode 2 & 3 – each single output is 1 group)

ColorSpan2 v1.6	Control Mode 1 [13ch] 7fx + 2 x HSI	Control Mode 2 [6ch] 2 x HSI	Control Mode 3 [6ch] 2 x RGB (with*Magic Amber)
Channel 1	Grouping 0-100 Variable grouping range between 1-2 cells with FX running within the group. 102-206 variable grouping range between 1-2 cells with FX running between the groups. 209-255 Variable grouping range for every 2nd to every 18th cell in a group.	Hue for output 1	Red for output 1
Channel 2	Color Speed 0-255 Variable speed of color scrolling. From static at 0 to maximum at 255.	Saturation for output 1	Green for output 1
Channel 3	Color Fan 0-255 Variable fan of color between / within groups. All units are the same color at 0.	Intensity for output 1	Blue for output 1
Channel 4	Color Range 0 Full spectrum 1-255 Variable limit of spectrum for color scrolling. Single color at 1, full spectrum at 255.	Hue for output 2	Red for output 2
Channel 5	Color Step 0-255 Variable control of smoothness of color scrolling. Smoothest is at 0. Most coarse is at 250. Rate will vary with scrolling speed. 255 will override effects and switch to RGB.	Saturation for output 2	Green for output 2
Channel 6	Intensity Effects 0 Static 1-63 Fade on, fade off. Variable range, 63 the fastest 64-127 Fade on, snap off. Variable range, 127 the fastest 128-191 Snap on, fade off. Variable range, 191 the fastest. 192-255 Snap on, snap off (strobe). Variable range, 255 the fastest.	Intensity for output 2	Blue for output 2
Channel 7	Intensity Fan 0-255 Variable fan of intensity effect between / within groups. All units at the same intensity at 0. Alternating units on and off at 255.		
Channel 8	Hue for output 1		
Channel 9	Saturation for output 1		
Channel 10	Intensity for output 1		
Channel 11	Hue for output 2		
Channel 12	Saturation for output 2		
Channel 13	Intensity for output 2		
Total DMX Channels	13 DMX channels	6 DMX channels	6 DMX channels

Color Span PS02 DMX Personality Mode 4-6: (All 2 outputs as 1 group)

Color Span 2 v1.6	Control Mode 4 [9ch] 6fx + HSI	Control Mode 5 [3ch] 1 x HSI	Control Mode 6 [3ch] 1 x RGB (with *Magic Amber)
Channel 1	Color Speed 0-255 Variable speed of color scrolling. From static at 0 to maximum at 255.	Hue for all 2 outputs	Red for all 2 outputs
Channel 2	Color Fan 0-255 Variable fan of color between / within groups. All units are the same color at 0.	Saturation for all 2 outputs	Green for all 2 outputs
Channel 3	Color Range 0 Full spectrum 1-255 Variable limit of spectrum for color scrolling. Single color at 1, full spectrum at 255.	Intensity for all 2 outputs	Blue for all 2 outputs
Channel 4	Color Step 0-255 Variable control of smoothness of color scrolling. Smoothest is at 0. Most coarse is at 250. Rate will vary with scrolling speed. 255 will override effects and switch to RGB.		
Channel 5	Intensity Effects 0 Static 1-63 Fade on, fade off. Variable range, 63 the fastest 64-127 Fade on, snap off. Variable range, 127 the fastest 128-191 Snap on, fade off. Variable range, 191 the fastest. 192-255 Snap on, snap off (strobe). Variable range, 255 the fastest.		
Channel 6	Intensity Fan 0-255 Variable fan of intensity effect between / within groups. All units at the same intensity at 0. Alternating units on and off at 255.		
Channel 7	Hue for output 1		
Channel 8	Saturation for output 1		
Channel 9	Intensity for output 1		
Total DMX Channels	9 DMX channels	3 DMX channels	3 DMX channels

Color Span PS02 DMX Personality Mode 7-10:

(Mode 7 & 8 – each output is 1 group/cell; Mode 9 & 10 – all 2 outputs as 1 group)

Color Span 2 v1.6	Control Mode 7 [8ch] 2 x RGBA	Control Mode 8 [8ch] 2 x RGBI (with *Magic Amber)	Control Mode 9 [4ch] 1 x RGBA	Control Mode 10 [4ch] 1 x RGBI (with *Magic Amber)
Channel 1	Red for output 1	Red for output 1	Red for all 2 outputs	Red for all 2 outputs
Channel 2	Green for output 1	Green for output 1	Green for all 2 outputs	Green for all 2 outputs
Channel 3	Blue for output 1	Blue for output 1	Blue for all 2 outputs	Blue for all 2 outputs
Channel 4	Amber for output 1	Intensity for output 1	Amber for all 2 outputs	Intensity for all 2 outputs
Channel 5	Red for output 2	Red for output 2		
Channel 6	Green for output 2	Green for output 2		
Channel 7	Blue for output 2	Blue for output 2		
Channel 8	Amber for output 2	Intensity for output 2		
Total DMX Channels	8 DMX channels	8 DMX channels	4 DMX channels	4 DMX channels



Color Span PS18/PS06/PS02 DMX Personality Mode 11:

Color Span 2 v1.6	Mode 11 (1ch) Look Store					
Channel 1	Channel levels and the corresponding Look numbers:					
	Channel Level (%)	Look	Channel Level (%)	Look	Channel Level (%)	Look
	0	OFF	33-35	11	69-71	22
	1-2	1	36-38	12	72-74	23
	3-5	2	39-42	13	75-78	24
	6-9	3	43-45	14	79-81	25
	10-11	4	46-48	15	83-85	26
	12-15	5	49-51	16	86-88	27
	16-19	6	52-54	17	89-91	28
	20-22	7	56-58	18	92-94	29
	23-25	8	59-61	19	95-97	30
	26-27	9	62-64	20	98-100	31
	29-32	10	65-68	21		

### 3. Troubleshooting

Troubleshooting is a process of elimination. First, rule out the other field factors (i.e. bad connections, faulty cables and power supplies). For technical support and/or parts, please contact your selling dealer or the offices listed in this manual.

Symptom	Possible Cause	Solution
Fixture does not respond to DMX control.	The power supply unit is set to the wrong or different DMX address. Bad cable connecting DMX control and the power supply unit. Bad cable connecting the power supply unit and the fixture/s. Bad in/through connection between adjacent power supply units. Bad in/through connection between adjacent fixtures.	Check DMX address and Mode settings. Check/replace DMX run from the console to the power supply unit. Check/replace power & data cable from power supply unit to the fixture. Check/replace power & data cable between adjacent fixtures.

## 4. Specification

### 4.1 Technical Specifications

#### Color Span 2 Fixture Unit

Product Code	CHSP...(followed by your 5 option codes)		
Net Dimensions – (W x H x D)	400mm / 16" Length:	800mm / 32" Length:	1200mm / 48" Length:
IP20 Rated Enclosure	416mm x 87mm x 60mm / 16.4" x 3.4" x 2.4"	800mm x 87mm x 60mm / 32" x 3.4" x 2.4"	1213mm x 87mm x 60mm / 47.8" x 3.4" x 2.4"
IP67 Rated Enclosure	456mm x 101mm x 62mm / 17.9" x 4" x 2.5"	862mm x 101mm x 62mm / 33.9" x 4" x 2.5"	1269mm x 101mm x 62mm / 49.9" x 4" x 2.5"
Net Weight (Without Fixings)			
IP20 Rated Enclosure	1.1kg / 2.5lbs	2.0kg / 4.5lbs	2.8kg / 6.1lbs
IP67 Rated Enclosure	2.5kg / 5.5lbs	4.7kg / 10.4lbs	6.3kg / 13.8lbs
Shipping Dimensions - (W x H x D)	584mm x 152mm x 114mm / 23" x 6" x 4.5"	991mm x 152mm x 114mm / 39" x 6" x 4.5"	1,422mm x 152mm x 114mm / 56" x 6" x 4.5"
Shipping Weight:			
IP20 Rated Enclosure	1.5kg / 3.3lbs	2.8kg / 6.2lbs	3.7kg / 8.2lbs
IP67 Rated Enclosure	3kg / 6.5lbs	5.2kg / 11.5lbs	6.8kg / 15lbs
LEDs	4x RGBA, total 16 LEDs	8x RGBA, total 32 LEDs	12x RGBA, total 48 LEDs
Power Input Rating	See power supply specification sheets		
Power Connector In/Out	1 x RJ45 Chassis – in / 1 x RJ45 Chassis – out		
Data Connector In/Out	1 x RJ45 Chassis – in / 1 x RJ45 Chassis – out		
Max Cable Run	5m / 16'		
Control Protocol	ANSI E1.11 USITT DMX 512-A		
Cooling System	Convection		
Operating Temperature	0°C to 40°C		
Construction	Anodised aluminium extrusion		
Color	Black, White, Silver, Gold, Green, Red, Pewter, Champagne, Blue & Light Bronze		
Built-In Hardware	Angle bracket for wall, ceiling & floor mounting		
Lamp Life	L70 up to 50,000 hours		
IP Rating	IP20 & IP67		
Approvals	EN55103-1:1996, EN55103-2:1996, ICES-003:2004, FCC PART 15 Subpart B:2006		
Control & Photometric			
LEDs	4 x RGBA	8 x RGBA	12 x RGBA
LED Engines	1	2	3
LEDs Per Engine	16	16	16
Total LEDs	16	32	48
Control Modes	See Color Span PS18, PS06 & PS02 specification sheets		
Dimming Curve	Theatrical		
Variable Effects Engine	See Color Span PS18, PS06 & PS02 specification sheets		
Effects Parameters	See Color Span PS18, PS06 & PS02 specification sheets		
Hot Lumen Output (Combined)	660 hot lumens (RGBA)	1300 hot lumens (RGBA)	2,000 hot lumens (RGBA)
Optics	Close focus lens		
Beam Angle	Narrow (12°), medium (23°) or wide (40°) (approx.)		
Beam Distribution	Symmetrical direct illumination		
CCT	Adjustable 1,000 - 10,000K		
Color Gamut	Performance enhanced		
CRI	92		

## Color Span Power Supply Units

Product Code	CHSPPS02	CHSPPS06	CHSPPS18
Net Dimensions (Without Fixings) - Width x Height x Depth	194mm x 140mm x 127mm / 7.6" x 5.5" x 5"	405mm x 362mm x 91mm / 16" x 14.3" x 3.6"	660mm x 483mm x 88mm / 26" x 19" x 3.5"
Net Weight (Without Fixings)	2.8 kg / 6.2 lbs	9.4kg / 20.6lbs	22kg / 49lbs
Shipping Dimensions - Width x Height x Depth	280mm x 185mm x 130mm / 11" x 7.3" x 5.1"	510mm x 450mm x 145mm / 20" x 17.7" x 5.7"	810mm x 520mm x 165mm / 32" x 20.5" x 6.5"
Shipping Weight	3.0kg / 6.7 lbs	10.5kg / 23lbs	25kg / 55lbs
Power & Connections			
Power Input Rating	100-240V AC, 50-60Hz, 3A	100-240V AC, 50-60Hz, 6A	100-240V AC, 50-60Hz, 16A
Maximum Power Output (Based on fully loaded PSU)	360W	720W	1920W
Power connector In/Out	IEC chassis male	IEC chassis male	Trailing lead
Data Connectors In/Out	RJ45		
Max cable run	5m / 16'		
Control Protocol	ANSI E.11 USITT DMX 512-A		
Cooling System	Ventilation required at the front, sides & top	1 x fan, ventilation required at the front & rear	5 x rear, 1 x side mounted fans, ventilation required at the front & rear
Operating Temperature	0°C to 40°C		
Construction	Powder coated aluminium		
Color	Black		
Built-In Hardware	N/A		
IP Rating	IP20		
Approvals	CISPR 22:2006/EN55022:2006, CISPR 24:1997/EN55024:1998, ICES-003:2004, FCC Part 15 Subpart B:2007, CSA C22. 166-M1983: R2008, CAN/CSA-C22.2 60950-1-07, UL 60950-1:2007		
Control			
Control Modes	13 channels fxHSI, 6 channels HSI, 6 channels RGB, 9 channels fxHSI, 3 channels HSI, 3 channels RGB, 8 channels RGBA, 8 channels RGBI, 4 channels RGBA, 4 channels RGBI, 1 channel LkSel, Demo	25 channels fxHSI, 18 channels HSI, 18 channels RGB, 9 channels fxHSI, 3 channels HSI, 3 channels RGB, 24 channels RGBA, 24 channels RGBI, 4 channels RGBA, 4 channels RGBI, 1 channel LkSel, Demo	61 channels fxHSI, 54 channels HSI, 54 channels RGB, 9 channels fxHSI, 3 channels HSI, 3 channels RGB, 72 channels RGBA, 72 channels RGBI, 4 channels RGBA, 4 channels RGBI, 1 channel LkSel, Demo
Dimming Curve	Theatrical		
Variable Effects Engine	Yes		
Effects Parameters	Grouping, colorspeed, color fan, color range, color step, intensity effects, intensity fan		

\*\*For exact measurements please refer to the line drawings below



# 4.2 Drawings – Dimensions

## Color Span Fixtures:

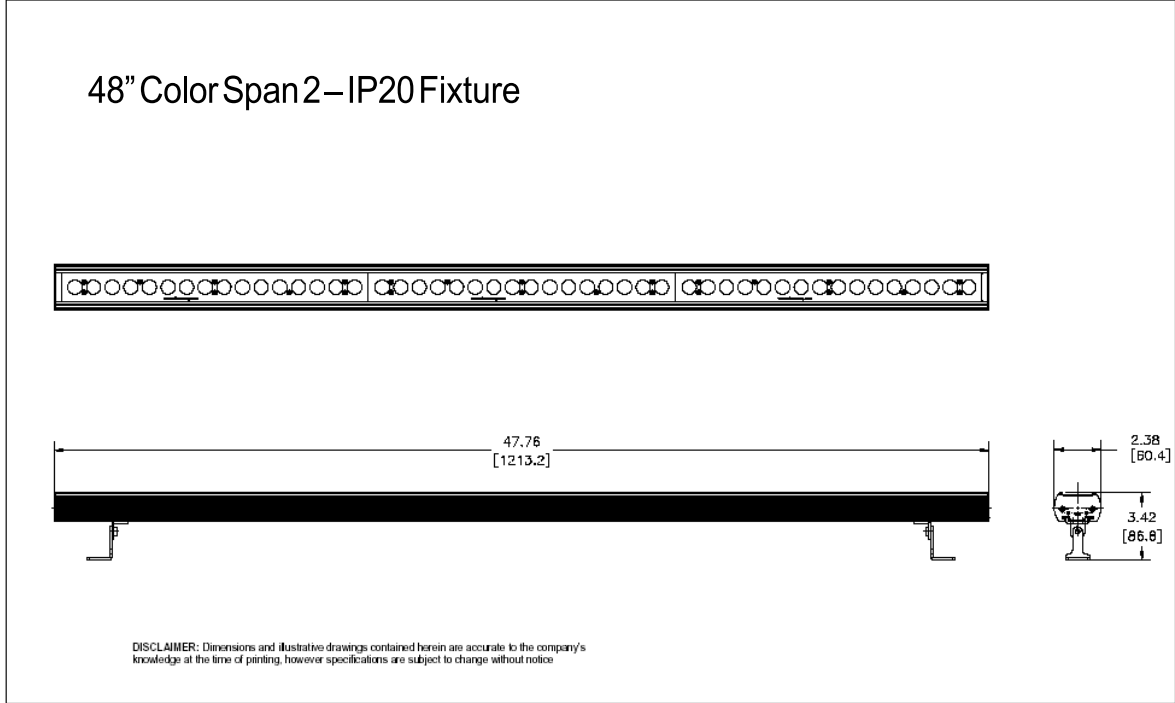

# 32" Color Span 2 – IP20 Fixture

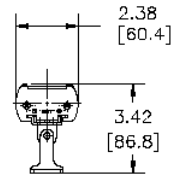
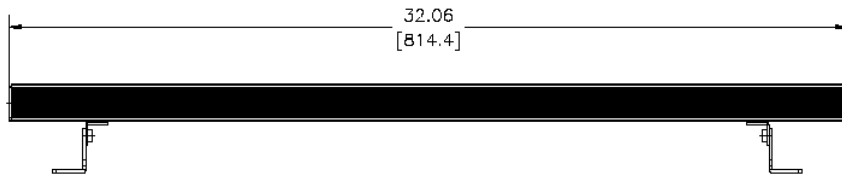
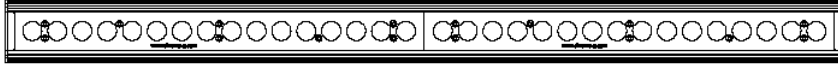

**DISCLAIMER:** Dimensions and illustrative drawings contained herein are accurate to the company's knowledge at the time of printing, however specifications are subject to change without notice

## 16" Color Span 2 – IP20 Fixture

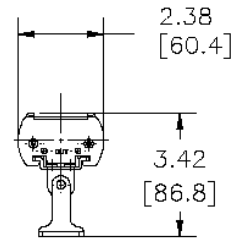
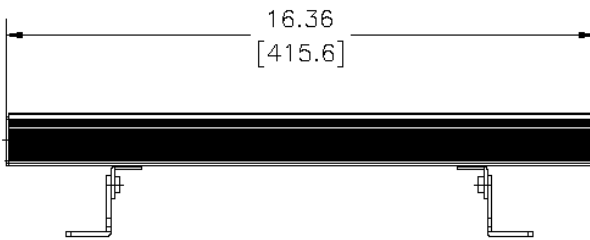
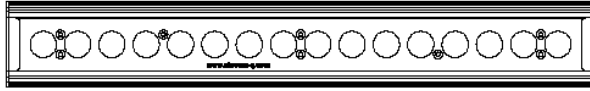

**DISCLAIMER:** Dimensions and illustrative drawings contained herein are accurate to the company's knowledge at the time of printing, however specifications are subject to change without notice

## 48" Color Span – IP67 Fixture

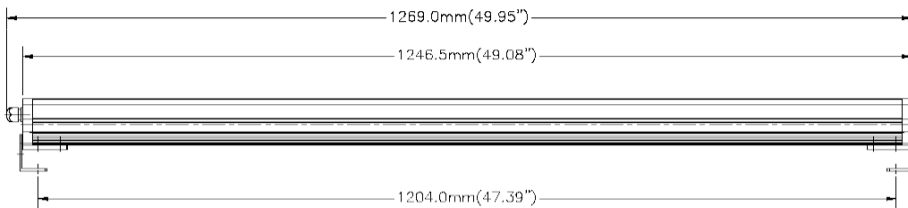

### 32" Color Span – IP67 Fixture

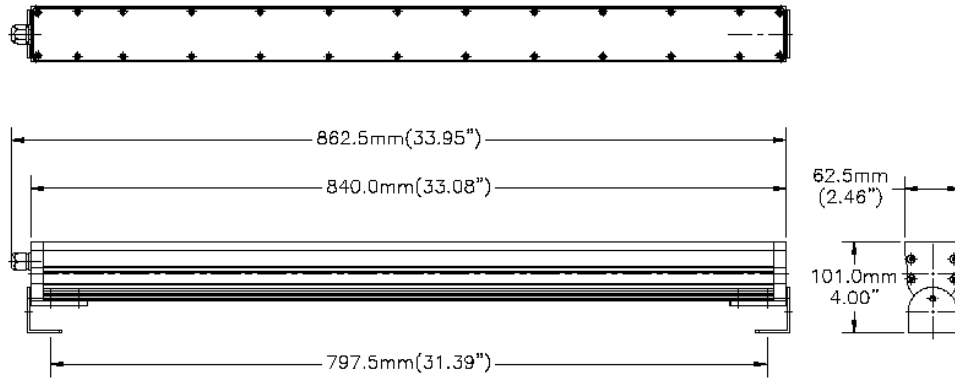

### 16" Color Span – IP67 Fixture

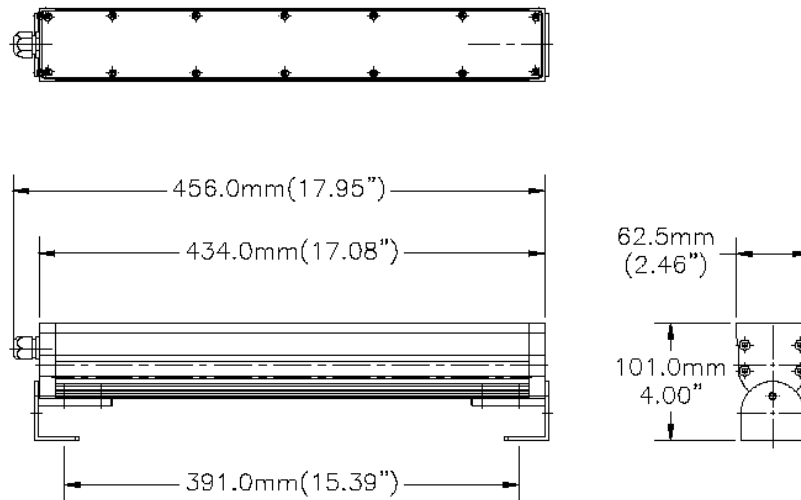

Color Span Power Supply Units:

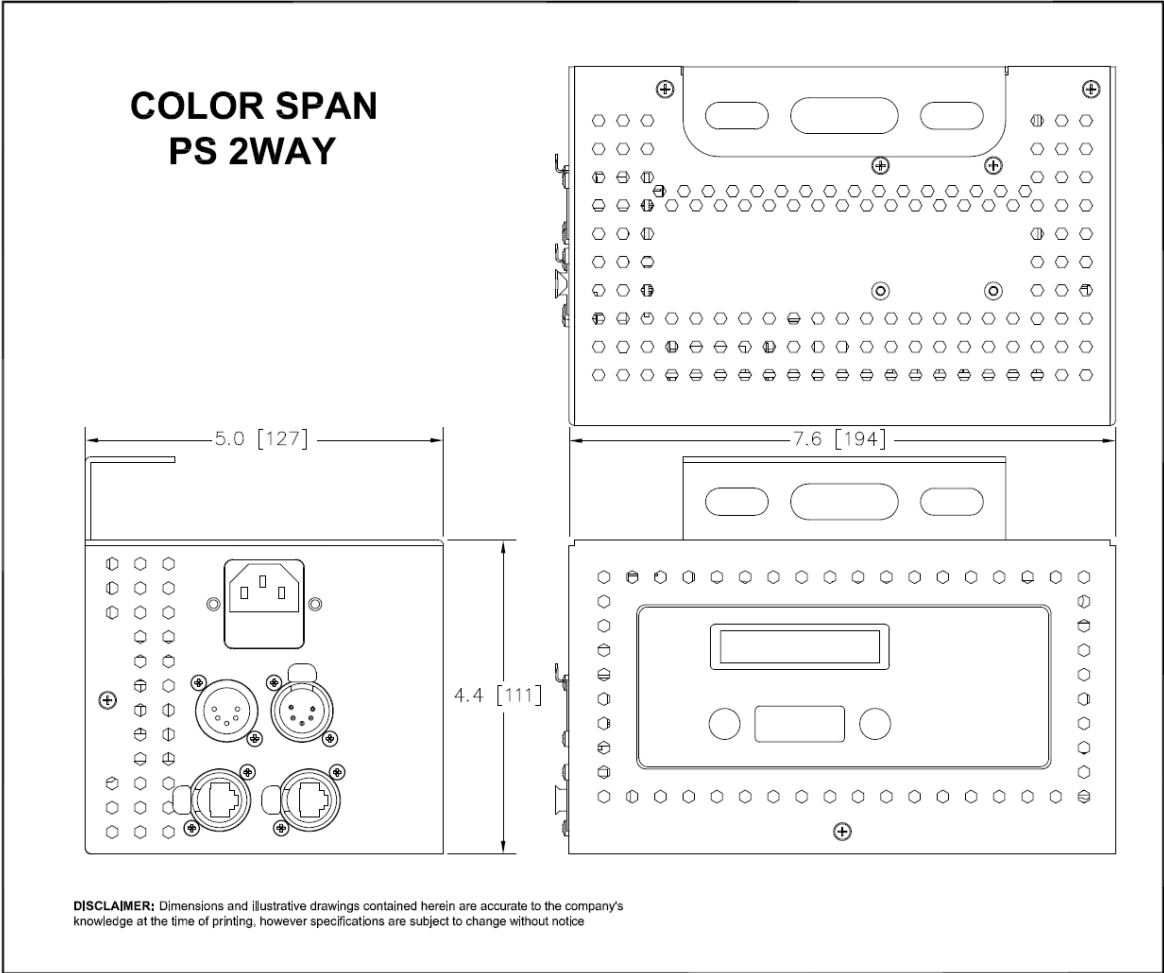



# COLOR SPAN PS06

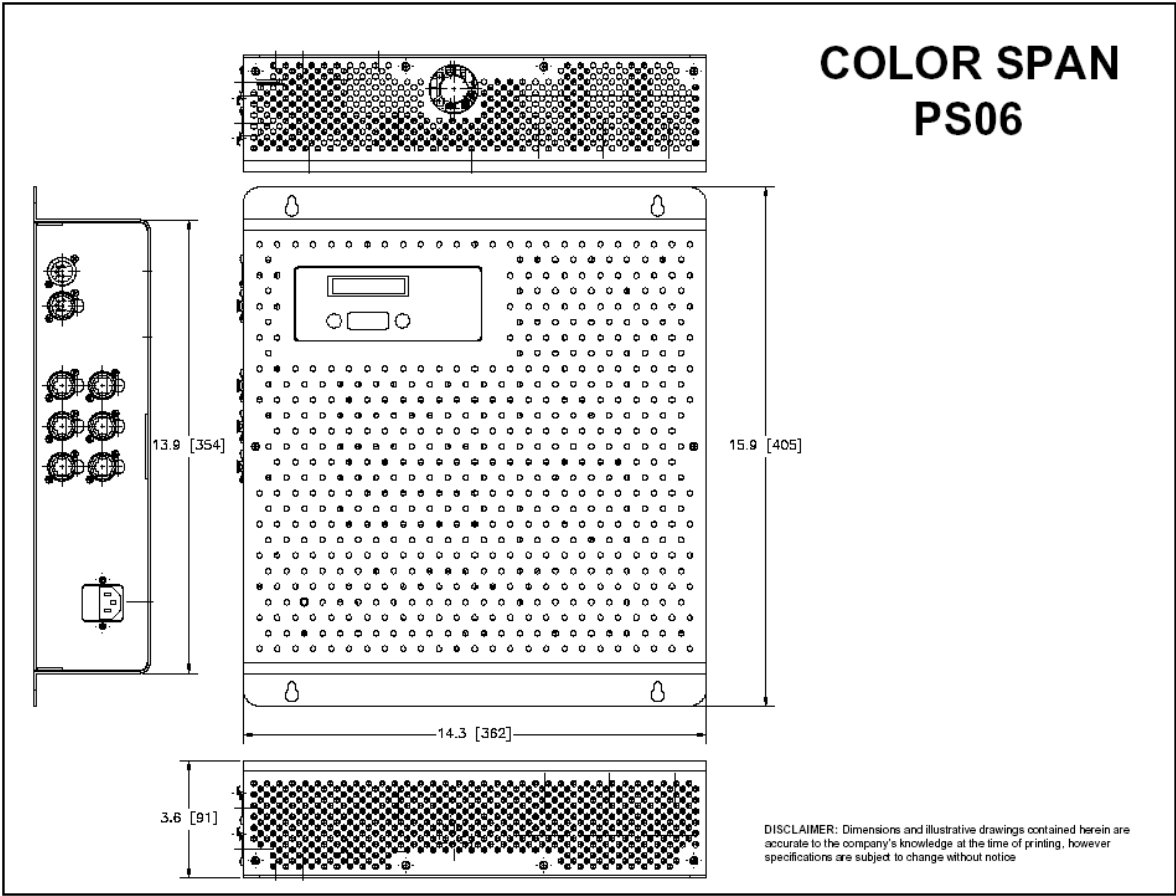

DISCLAIMER: Dimensions and illustrative drawings contained herein are accurate to the company's knowledge at the time of printing, however specifications are subject to change without notice

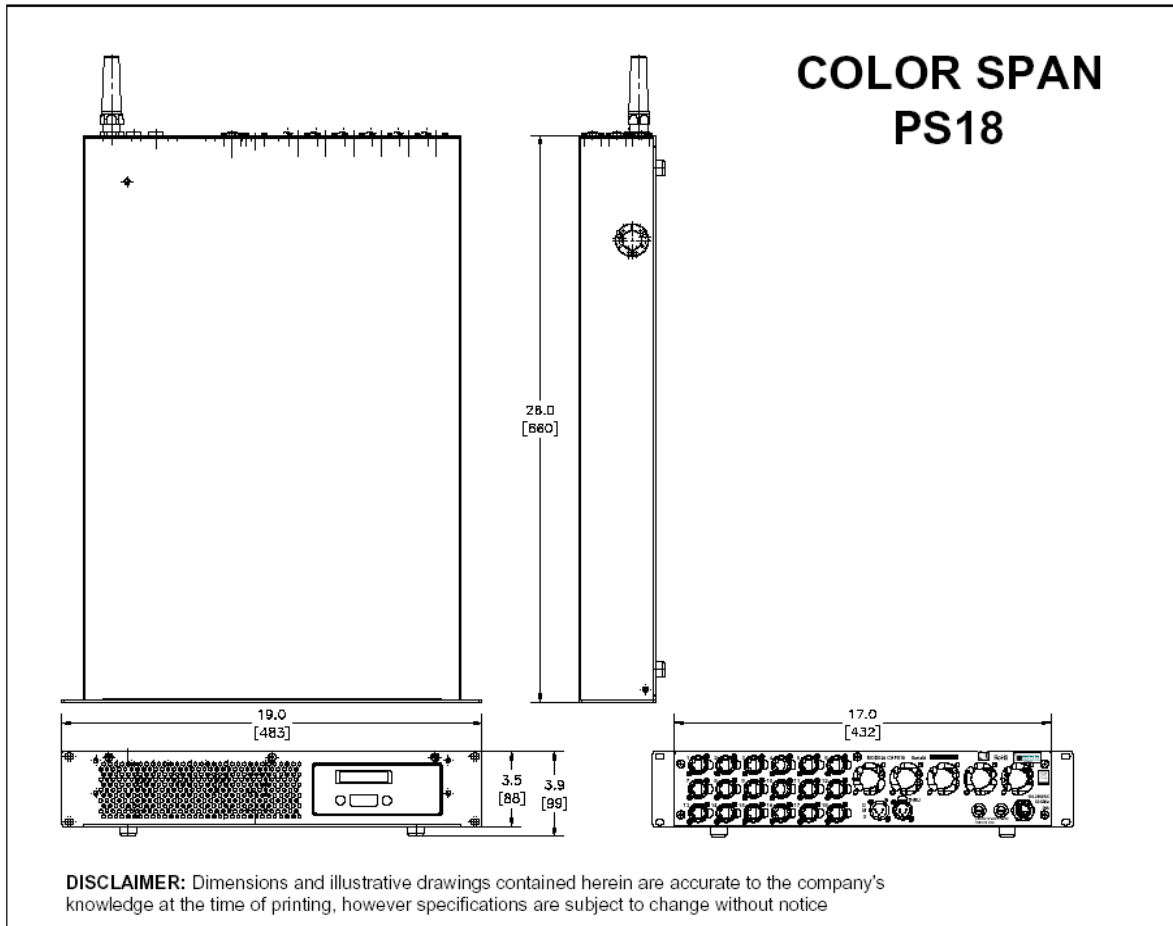

## 5. Maintenance

With care, the Color Span 2 system will require little maintenance. However, as the unit is likely to be used in a stage environment we recommend periodical internal inspection and cleaning of any resulting dust and cracked oil residue.

Do not spray liquids on the front or rear panel. If the front enclosure requires cleaning, wipe with a mild detergent on a damp cloth.