

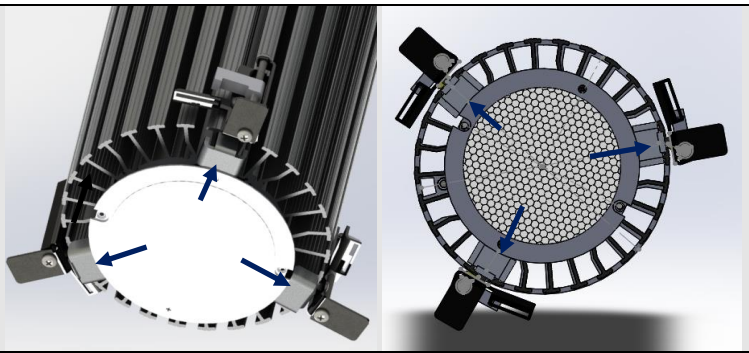
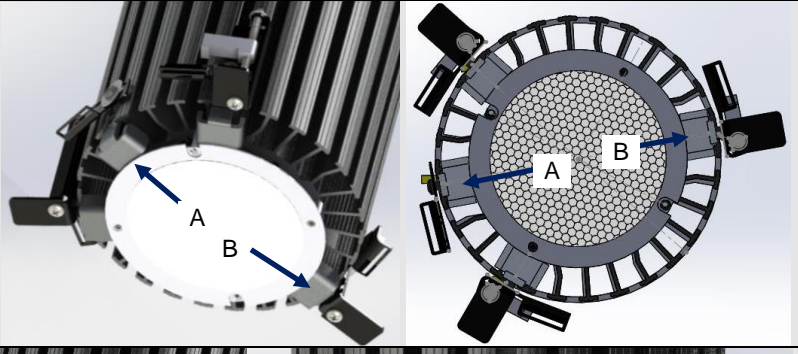
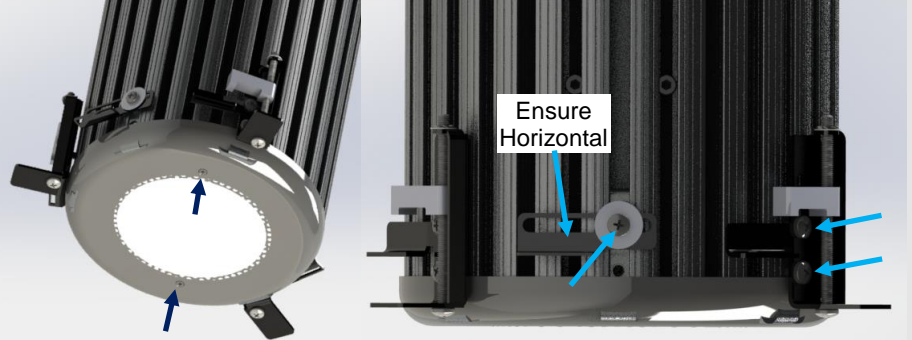
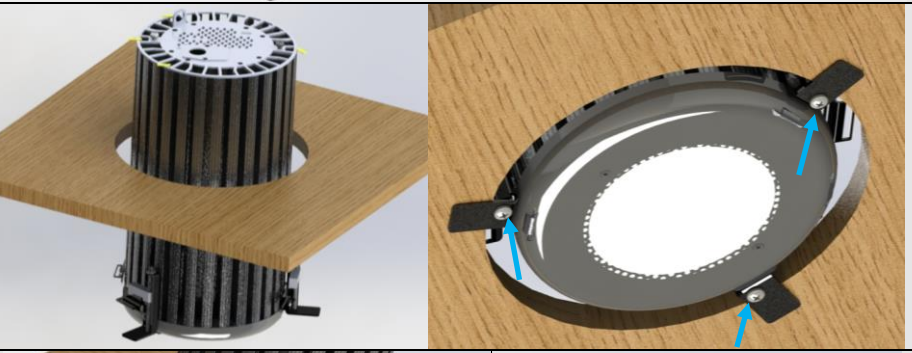

<p>2 Slide in the three "Bracket Clamp Sub-assembly" evenly spaced around the fixture as shown in the figure.</p>	
<p>3 Slide in the "Bracket Trim Ring Sub-assembly [A]" so that it is on the opposite side of one of the "Bracket Clamp Sub-assembly [B]"</p>	
<p>4 i. Replace the face plate on fixture, installing the two screws back on it. ii. Tighten seven M5X12 Screws on the four Sub-assemblies to make a solid connection on to the fixture. Ensure the slots of the brackets are horizontal</p>	
<p>5 Connect the power and data wiring to the fixture, secure the safety chain, then carefully put the fixture through the hole of the ceiling. Hold the fixture into position and tighten the three screws until it is clamped tight to the ceiling.</p>	
<p>6 Pinch the springs on the Trim Ring and insert them into the slots in "Bracket Trim Ring [A]" and "Bracket Clamp [B]" aligned in Step 3. Push firmly into place for tight fit. Adjust the Trim Ring to the centre of the lens.</p>	

Installation Guide

Chroma-Q[®]

Inspire[™]

Blind Ceiling Mount

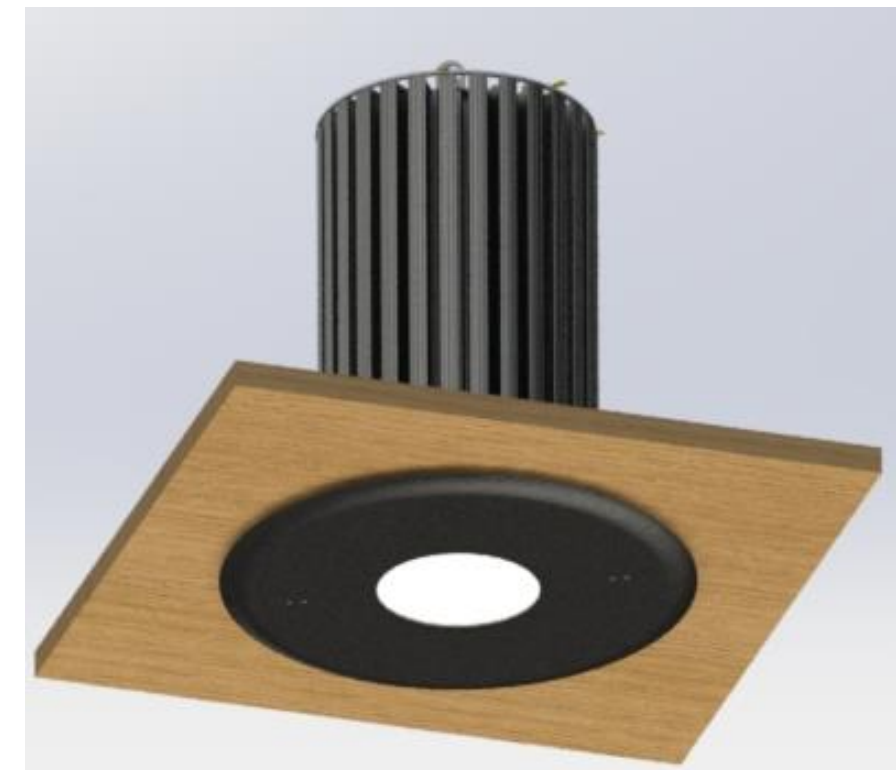

For Use With:

Model: 632-9120, 632-9121

Version 1.0

Approvals & Disclaimer



The information contained herein is offered in good faith and is believed to be accurate. However, because conditions and methods of use of our products are beyond our control, this information should not be used in substitution for customer's tests to ensure that Chroma-Q products are safe, effective, and fully satisfactory for the intended end use. Suggestions of use shall not be taken as inducements to infringe any patent. Chroma-Q sole warranty is that the product will meet the Chroma-Q sales specifications in effect at the time of shipment. Your exclusive remedy for breach of such warranty is limited to refund of purchase price or replacement of any product shown to be other than as warranted.

Chroma-Q reserves the right to change or make alteration to devices and their functionality without notice due to on-going research and development.

The Chroma-Q Inspire range has been designed specifically for the lighting industry. Regular maintenance should be performed to ensure that the products perform well in the entertainment environment.

If you experience any difficulties with any Chroma-Q products please contact your selling dealer. If your selling dealer is unable to help please contact support@chroma-q.com. If the selling dealer is unable to satisfy your servicing needs, please contact the following for full factory service:

Outside North America:
Tel: +44 (0)1494 446000
Fax: +44 (0)1494 461024
support@chroma-q.com

North America:
Tel: +1 416-255-9494
Fax: +1 416-255-3514
support@chroma-q.com

For further information please visit the Chroma-Q website at www.chroma-q.com.

Chroma-Q and Uploader are trademarks, for more information on this visit www.chroma-q.com/trademarks.

The rights and ownership of all trademarks are recognised.



Installation Disclaimer:

1. Installation should be carried out by an experienced professional. The instructions below are provided for information only.
2. All work should be verified to meet Local and National Building Regulations, and Health and Safety Standards in particular.
3. Ensure that the specified torque is applied to fasten the Trim Ring and Angle Supports.
4. The Angle Supports of the Inspire fixture must be fastened to the ceiling with the appropriate load capacity.
5. The use of a safety rated chain or other arrest cable is strongly recommended as per standard rigging practice.

1. KIT CONTENTS

Items	Part Number	Quantity
Trim Ring Blind Mount	632-9005 / 632-9006	1
Bracket Blind Mount Clamp	632-9001	3
Flag Blind Mount Clamp	632-9002	3
Screw M5X0.8 PH 80mm	450-1280-1	3
Push Nut M5 Thickness 1mm	450-3401	3
Bracket Trim Ring Mount	632-9004	1
Bracket Hook	632-0012	4
Screw M5X12 PH P/ps Blk	450-1212-0	7
Washer Flat M5 Zn 20mm OD	450-2420-1	4
Ceiling Blind Mount Install Guide	632-0721	1

For the ease of installation most items of the kit have been partially assembled. They are

Sub Assembly No.	Description	Quantity	Picture
A	Bracket Trim Ring Sub-assembly	1	
B	Bracket Clamp Sub-assembly	3	

2. Tools Required

Screwdriver with PH#1 (Minimum torque: 5.5 in-lb.)

3. Installation Guide

Hole Sizing Reference (inches/cm)

Note:

- Ceiling hole size: 8.5" / 21.5 cm
- Trim Ring outer diameter: 12" / 30.5 cm
- Trim Ring inner diameter: 4" / 10 cm

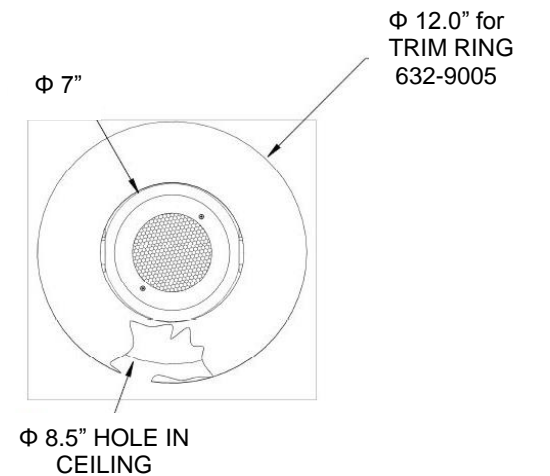

- 1 Remove the face plate of the fixture by taking out 2 x M3 flat head screws

