

Installation Guide

Chroma-Q®

2inspire™

HONEYCOMB LOUVER

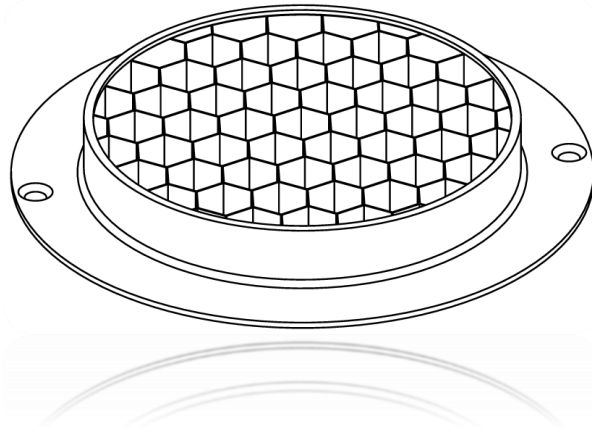

Chroma-Q®
BRILLIANT SOLUTIONS

For a full product manual please visit www.chroma-q.com

For use with

Part Number: CQ1509-9136, CQ1509-9137,
CQ1509-9236, CQ1509-9237,
CQ1509-9336, CQ1509-9337.

Model: 1509-9136, 1509-9137, 1509-9236, 1509-9237,
1509-9336, 1509-9337.

Items in the Kit**:

Description	2inspire 100		2inspire 200		2inspire 300		QTY
	Black (1509-9136)	White (1509-9137)	Black (1509-9236)	White (1509-9237)	Black (1509-9336)	White (1509-9337)	
EGG CRATE RING	1509-0476	1509-0477	1509-0481	1509-0482	1509-0486	1509-0487	1
HONEYCOMB GRID	1509-0185	1509-0186	1509-0285	1509-0286	1509-0385	1509-0386	1
PLPS SCREW	425I-1160	425I-1161	430-1116-0	430-1116-1	430-1116-0	430-1116-1	2

1. Tools Required

- 2.5mm/3mm Allen Key
- Phillips Head Screwdriver

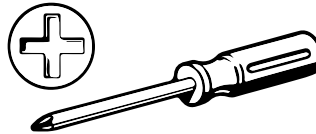
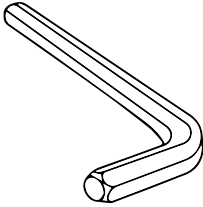

2. Installation Procedure (in Sequence)

1. Remove the two Socket Head screws from the main fixture diagonally with an Allen Key.

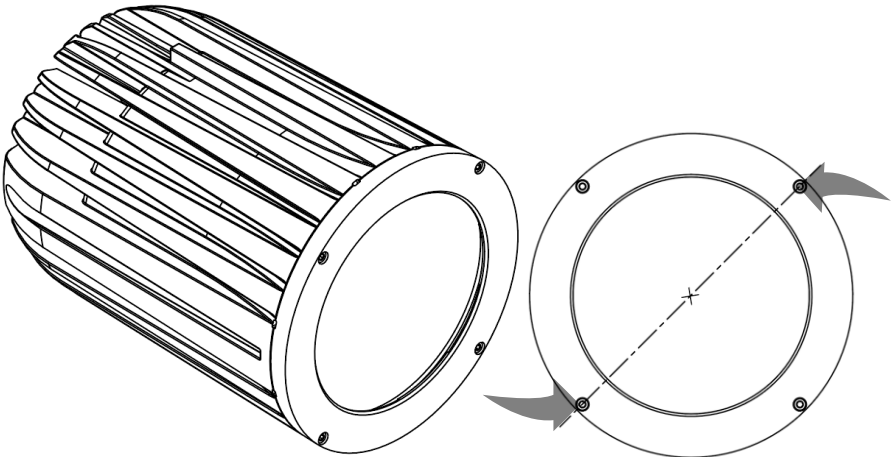

- Align the Honeycomb Louver with the main fixture.

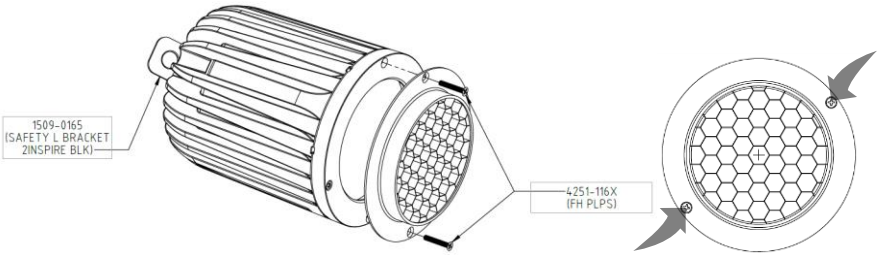

- Assemble the Phillips head screws through the Honeycomb Louver and into the main fixture.
- Tighten each of the screws on either side with a Phillips head screwdriver.

****Refer to the table (Items in the kit) to identify the parts 1509-XXXX**

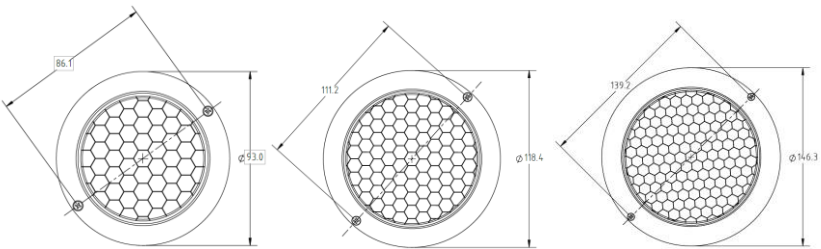
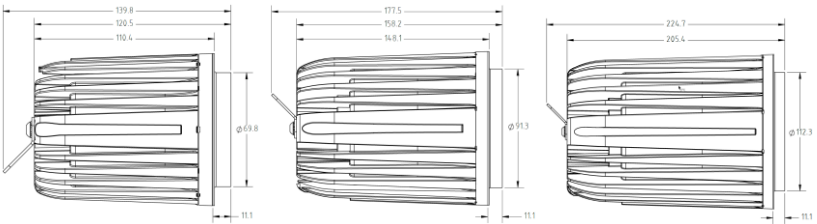

1501 Model

1502 Model

1503 Model

Disclaimer

Dimensions and illustrative drawings contained herein are accurate to the company's knowledge at the time of printing, however specifications are subject to change without notice.

Further Information

Please refer to the Chroma-Q 2inspire™ Manual for more detailed information about the fixture. A copy of the manual can be found at the Chroma-Q website – <http://www.chroma-q.com/support/downloads.asp>

Approvals & Disclaimer



The information contained herein is offered in good faith and is believed to be accurate. However, because conditions and methods of use of our products are beyond our control, this information should not be used in substitution for customer's tests to ensure that Chroma-Q products are safe, effective, and fully satisfactory for the intended end use. Suggestions of use shall not be taken as inducements to infringe any patent. Chroma-Q sole warranty is that the product will meet the Chroma-Q sales specifications in effect at the time of shipment. Your exclusive remedy for breach of such warranty is limited to refund of purchase price or replacement of any product shown to be other than as warranted.

Chroma-Q reserves the right to change or make alteration to devices and their functionality without notice due to on-going research and development.

The Chroma-Q 2inspire™ has been designed specifically for the lighting industry. Regular maintenance should be performed to ensure that the products perform well in the entertainment environment.

If you experience any difficulties with any Chroma-Q products please contact your selling dealer. If your selling dealer is unable to help please contact support@chroma-q.com. If the selling dealer is unable to satisfy your servicing needs, please contact the following for full factory service:

Outside North America:	North America:
Tel: +44 (0)1494 446000	Tel: +1 416-255-9494
Fax: +44 (0)1494 461024	Fax: +1 416-255-3514
support@chroma-q.com	support@chroma-q.com

For further information please visit the Chroma-Q website at www.chroma-com.

Chroma-Q is a trademark, for more information on this visit www.chroma-q.com/trademarks.

The rights and ownership of all trademarks are recognized.